

5

Drivenax Mechanical transmission for tube expansion

Maus Italia offers a comprehensive range of shafts and fittings for the mechanical transmission of rotation from motor to mandrel.

Maus Italia's technical staff are at your disposal to recommend the optimum solution for each situation.

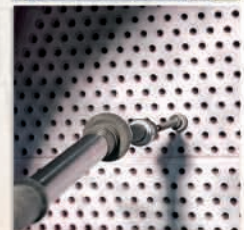

Telescopic shafts



A range of articulated telescopic shafts belonging to the **F/308** and **F/308 HS** series, that effectively transmit rotational speed from the motor to the tube expander by mechanical means:

- The brand-new **F/308 HS**, the technological evolution of the **F/308** model featuring innovative design solutions, is recommended for high-speed operation, due to its **special dexterity, accuracy and stability**.
- The traditional **F/308**, which has been in production for many years, is now exclusively offered in the **F/308-4** version for heavy transmission.



Quick couplings

The **mechanical transmission** between the articulated telescopic shaft and mandrel is **made by female/female couplings** offered by Maus Italia in 3 families:

The brand new joints with double quick coupling **F/314 HS** and **F/317 HS**, like the traditional **F/313** and **F/316**, facilitate **extremely quick tube expander replacement**. The new, **patented design** keeps the input shaft, **F/308 HS**, perfectly balanced and aligned with the tube expander, ensuring vibration levels are well below allowable thresholds



Fixed joints

The range also includes the fixed joints of the **F/315** and **F/318** series; the latter are used on the **F/308-4** telescopic shaft.



Extensions and articulated joints

A full range of extensions and articulated joints are available when working in situations with difficult access conditions.



Ratchet wrenches

The offer finally includes a set of extraordinarily strong reversible ratchet wrenches, specially designed for heavy duty, manual tube expansion.



Drivenax

MAUS
ITALIA



AC-36

© MAUS
ITALIA

F/308 HS F/308

Universal telescopic shaft

Special versions available upon request

Maus Italia offers the universal telescopic shafts belonging to the **F/308 HS** and **F/308** series, facilitating the effective transmission of rotational speed from the motor to the tube expander:

- The brand-new **F/308 HS**, the technological evolution of **F/308** featuring new innovative design solutions, is recommended for use at speeds exceeding 400 revolutions/min (r.p.m.) due to its special dexterity, accuracy and stability. The **F/308** model, however, also allows the use of joints belonging to the old **F/316** and **F/315** series.
- The traditional **F/308**, which has been in production for many years, is now exclusively offered in the **F/308** version for heavy transmission.

F/308 HS

F/308 HS	N	Handle A		Telescopic range B		Extendability		Max. motor torque		Weight		∅M	Recommended joints
Code		mm	inches	mm	inches	mm	inches	Nm	Lb Ft	Kg	Lb		
F308HS-2	3	205	8.1	650÷1060	25.6÷41.7	410	16.1	70	51	5,4	11.90	12	F/314 HS, F/313
F308HS-3	3	225	8.9	650÷1060	25.6÷41.7	410	16.1	135	99	7,9	17.41	18	F/317 HS, F/316, F/315
* F308HS-3L	3	225	8.9	850÷1460	33.5÷57.5	610	24.0	135	99	8,9	19.62	18	F/317 HS, F/316, F/315

* Version with extra extendability for use with mandrels whose length exceeds 500 mm (19,7")

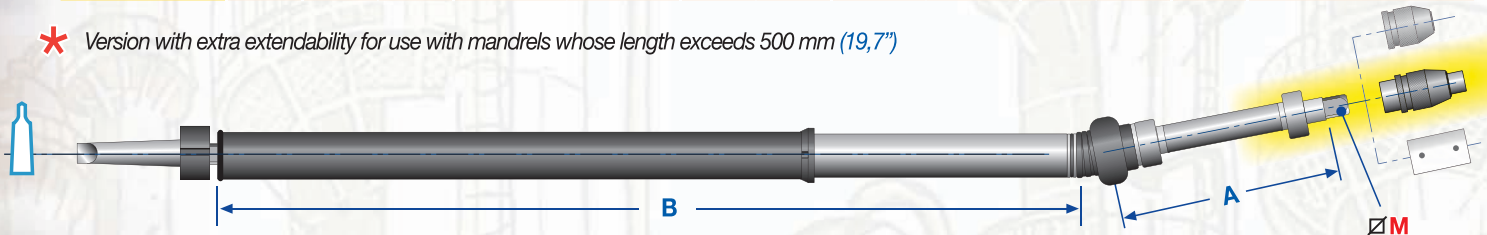

F/308

F/308 HS	N	Handle A		Telescopic range B		Extendability		Max. motor torque		Weight		∅M	Recommended joints
Code		mm	inches	mm	inches	mm	inches	Nm	Lb Ft	Kg	Lb		
F308-4	4	260	10.2	650÷1170	25.6÷461.7	520	205.1	1500	1106	16,5	36.37	24	F/318

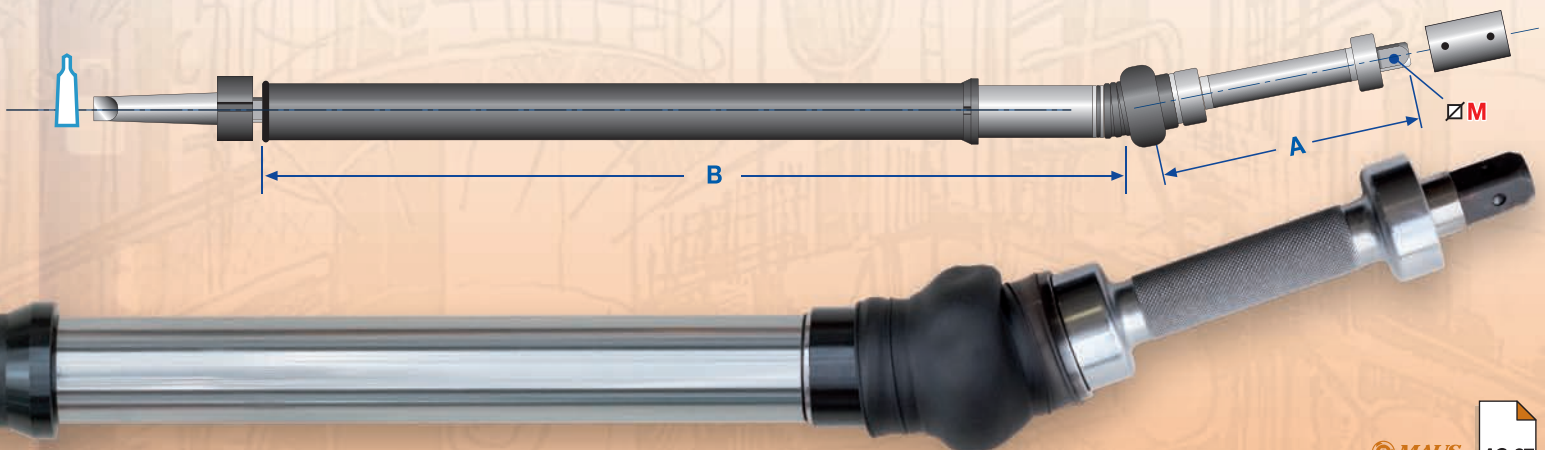

NEW

F/314 HS

∅ F

Code

inches

F314HS-1/4"

1/4"

F314HS-3/8"

3/8"

F/317 HS

∅ F

Code

inches

F317HS-3/8"

3/8"

F317HS-1/2"

1/2"

F/313

∅ F

Code

inches

F313-1/4"

1/4"

F313-3/8"

3/8"

F313-1/2"

1/2"

F/316

∅ F

Code

inches

F316-3/8"

3/8"

F316-1/2"

1/2"

F316-3/4"

3/4"

F/315

∅ F

Code

inches

F315-1/2"

1/2"

F315-3/4"

3/4"

F315-1"

1"

F/318

∅ F

Code

inches

F318-3/4"

3/4"

F318-1"

1"



NO VIBRATION



F/314 HS F/317 HS

Patented
pending

Joints with female/female
double quick couplings
specifically for high speed

F/314 HS and **F/317 HS** double quick coupling joints facilitate extremely quick tube expander replacement. The new, patented design keeps the input shaft, **F/308 HS**, perfectly balanced and aligned with the tube expander, ensuring vibration levels are well below allowable thresholds.

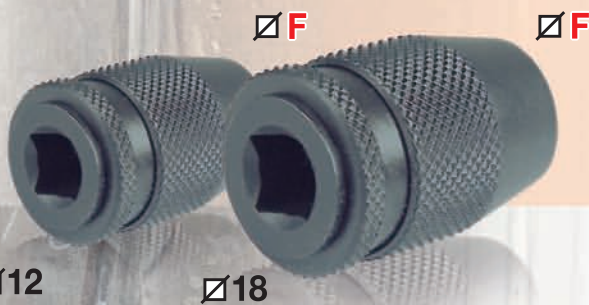

F/313 F/316

Joints with female/female
double quick couplings

The double quick coupling joints **F/313** and **F/316** are still in production as spare parts for the many telescopic shafts of the **F/308** series existing on the market.

F/315 F/318

Fixed
female/female joints

The range also includes the fixed joints of the **F/315** and **F/318** series; the latter are used on the **F/308-4** telescopic shaft.

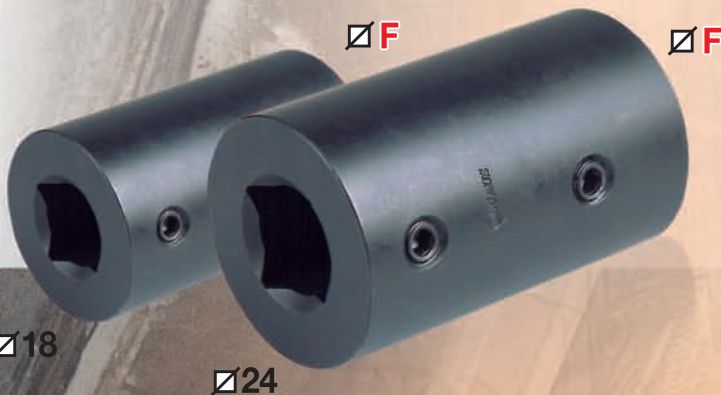

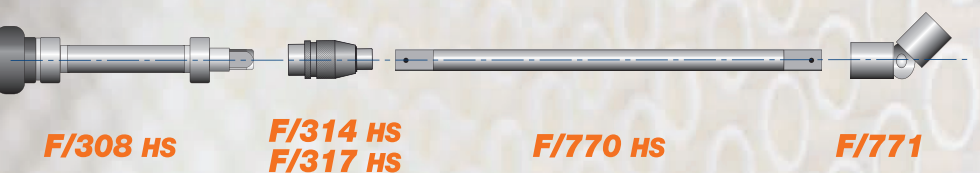

F/770 HS	\varnothing M1	\varnothing M2
Code	inches	mm inches
F770HS-3/8"-12	3/8"	12
F770HS-3/8"-18	3/8"	18
F770HS-1/2"-12	1/2"	12
F770HS-1/2"-18	1/2"	18
F770HS-3/4"-18	3/4"	18
F770HS-3/8"-24	3/8"	24
F770HS-1"-24	1"	24
F770HS-3/8"-3/8"	3/8"	3/8"
F770HS-1/2"-1/2"	1/2"	1/2"
F770HS-3/4"-3/4"	3/4"	3/4"

F/771	F1=F2
Code	inches
F771-3/8"	3/8"
F771-1/2"	1/2"
F771-3/4"	3/4"
F771-1"	1"

F/680	\varnothing F
Code	inches
F680-2	3/8" - 1/2"
F680-4	1/2" - 3/4" - 1"
F680-6	1.1/4" - 1.1/2"



F/770 HS

Rigid extension with
male-male
square ends

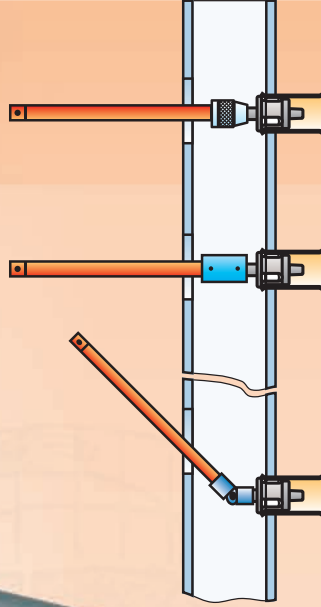

∅ M1



∅ M2

Rigid extension ideal for mechanical transmission adaptation, solving the problem of **expansion in hard to access areas**. Standard length **L = 300 mm (11.811")**. Different lengths available upon request.

F/771

Universal
joint

The universal joint for coupling with extension of the series **F/770**, allows a further adjustability of the mechanical transmission solving the problem of the **tube expansion in areas with difficult access**.



∅ F2

∅ F1

F/680

Square hole
reversible ratchet wrench
for manual expansion



∅ F

The offer finally includes a set of extraordinarily strong reversible ratchet wrenches, specially designed for the heavy duty requirements of manual expanding.

6

LubRol **Special lubricating** **paste for expanding**

With its **LubRol** offer, Maus Italia has selected two lubricating products designed to prolong the life of tube expanders.

The two products, labelled **GSA-4** and **LBR-15**, differ by their consistency.

Maus Italia's **technical staff** are at your disposal to recommend the optimum product and quantity for each situation.